

PRODUCT

CATALOG



Peace of Mind is our Specialty.



TABLE OF CONTENTS

- 4 | About Us
- 5 | Our Brand Partners
- 7 | Brackets & Tubes
- 18 | Archwires
- 24 | Distalizers
- 26 | Elastomerics
- 34 | Attachments
- 39 | Accessories
- 43 | Bonding Materials



50 | Impression Materials

55 | Kits & Replenishments

64 | Expansion Screws

69 | Herbst Parts

76 | MARA Parts

79 | Instruments & Tools

87 | Patient Aids





ABOUT US

OUR MISSION:

With more than 40 years of excellence, Specialty Appliances was founded in 1981 and is known for their industry-leading quality, unparalleled customer service, and reliable delivery times. We offer appliances and products that help you reduce chair time and increase practice profits. Our investment in the latest technologies and innovations means you get the best quality appliances and products at a competitive price.

OUR VISION:

We are the helping hand to the orthodontist (or dentist) to enable them to provide their patients with a perfect smile!

Our commitment to orthodontic practitioners is to:

- Be fair and transparent
- Stand by our products and work
- Do what we say
- Innovate products and processes
- Continuously improve
- Grow your practice

Peace of Mind is our Specialty.



OUR BRAND PARTNERS

ORTHOMETRIC



GC ORTHO



DENTMIX



DENTAURUM





BRACKETS & TUBES

Metal Twin Brackets 

U-Clip Self-Ligating Brackets 

ICERam-P Polycrystalline Brackets 

Advanced Series Tubes 

ICERam Mini Tubes 



ADVANCED SERIES METAL TWIN BRACKETS

The Orthometric Advanced Series metal twin bracket is produced with the modern Metal Injection Molding (MIM) metallurgy process. The excellent retention, precision of prescriptions, and anatomical design achieved by this production process provide a more efficient and comfortable treatment.

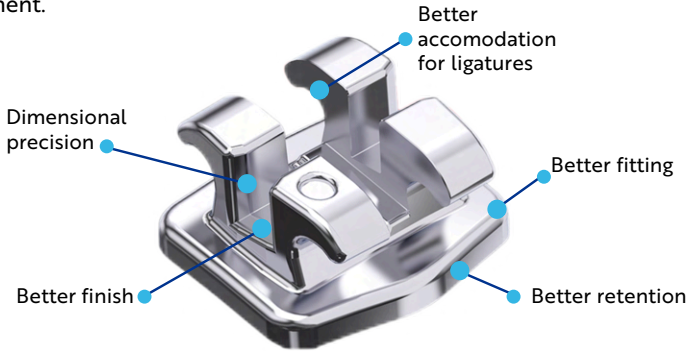

The modern technology employed in the construction of the molds results in an extremely precise bracket prescriptions and with an excellent surface finish



The twin wings design allows for easier placement and retention of ligatures, better rotational control, and less friction.



Features the exclusive patented LB2 - Laser Bonded Booster, a laser texturing process on the base to increase retention, ensuring greater adhesion efficiency.



The smooth, rounded hooks and edges ensure that your patients have a comfortable experience.

ADVANCED SERIES ROTH 0.022 BRACKETS:

TORQUE	-7°	-7°	-2°	+8°	+12°	+12°	+8°	-2°	-7°	-7°
ANGULATION	0°	0°	11°	9°	5°	5°	9°	11°	0°	0°
HOOK	✓	✓	✓	-	-	-	-	✓	✓	✓
WIDTH (mm)	2.8	2.8	2.8	2.8	3.0	3.0	2.8	2.8	2.8	2.8
ITEM NUMBER	900903	900903	900902	900901	900900	900904	900905	900906	900907	900907
	5 15	4 14	3 13	2 12	1 11	1 21	2 22	3 23	4 24	5 25
	UR4/5	UR4/5	UR3	UR2	UR1	UL1	UL2	UL3	UL4/5	UL4/5
MAXILLARY										
	Upper Right									Upper Left
MANDIBULAR										
	Lower Right									Lower Left
	LR5	LR4	LR3	L2-2	L2-2	L2-2	L2-2	LL3	LL4	LL5
	45 5	44 4	43 3	42 2	41 1	31 1	32 2	33 3	34 4	35 5
TORQUE	-22°	-17°	-11°	0°	0°	0°	0°	-11°	-17°	-22°
ANGULATION	0°	0°	5°	0°	0°	0°	0°	5°	0°	0°
HOOK	✓	✓	✓	-	-	-	-	✓	✓	✓
WIDTH (mm)	2.8	2.8	2.8	2.4	2.4	2.4	2.4	2.8	2.8	2.8
ITEM NUMBER	900914	900913	900912	900908	900908	900908	900908	900909	900910	900911



Sold in 5-5 kits and bags of 10 brackets/tooth.

PRESCRIPTION	ITEM NUMBER
5-5 KIT	900800

ADVANCED SERIES MBT 0.022 BRACKETS:

Brackets & Tubes

TORQUE	-7°	-7°	0°	+10°	+17°	+17°	+10°	0°	-7°	-7°
ANGULATION	0°	0°	0°	8°	4°	4°	8°	0°	0°	0°
HOOK	✓	✓	✓	-	-	-	-	✓	✓	✓
WIDTH (mm)	2.8	2.8	2.8	2.8	2.8	2.8	2.8	2.8	2.8	2.8

ITEM NUMBER	900918	900918	900917	900916	900915	900919	900920	900921	900922	900922
	5 15	4 14	3 13	2 12	1 11	1 21	2 22	3 23	4 24	5 25
	UR4/5	UR4/5	UR3	UR2	UR1	UL1	UL2	UL3	UL4/5	UL4/5
MAXILLARY										
	Upper Right	Lower Right							Upper Left	Lower Left
MANDIBULAR										
	LR5	LR4	LR3	L2-2	L2-2	L2-2	L2-2	LL3	LL4	LL5
	45 5	44 4	43 3	42 2	41 1	31 1	32 2	33 3	34 4	35 5

TORQUE	-17°	-12°	0°	-6°	-6°	-6°	-6°	0°	-12°	-17°
ANGULATION	2°	2°	3°	0°	0°	0°	0°	3°	2°	2°
HOOK	✓	✓	✓	-	-	-	-	✓	✓	✓
WIDTH (mm)	2.8	2.8	2.8	2.4	2.4	2.4	2.4	2.8	2.8	2.8

ITEM NUMBER	900929	900928	900927	900923	900923	900923	900923	900924	900925	900926
-------------	--------	--------	--------	--------	--------	--------	--------	--------	--------	--------



Sold in 5-5 kits and bags of 10 brackets/tooth

PRESCRIPTION	ITEM NUMBER
5-5 KIT	900802

U-CLIP SELF-LIGATING BRACKET

U-Clip is an interactive self-ligating bracket with a Nickel-Titanium Clip. Its elasticity and memory allow the bracket to return to its original position without permanent deformations. The interactions between the clip and archwire exert light and continuous force, ensuring the best movement control.

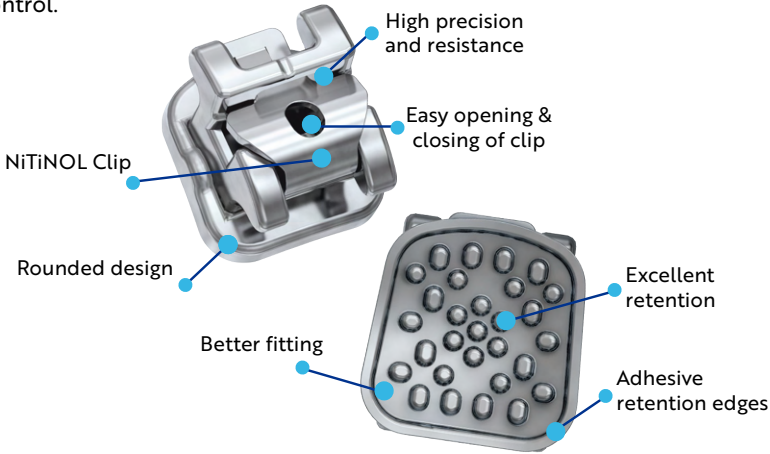

INTERACTIVE SYSTEM PASSIVE PHASE:

The clip in the passive function reduces friction, increasing the efficiency of the sliding mechanics during the initial stages of treatment and promoting quick alignment and leveling. There is no pressure on the clip when using round archwires, making teeth movement more comfortable for the patient.

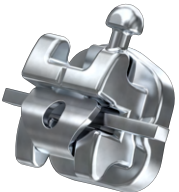

INTERACTIVE SYSTEM ACTIVE PHASE:

In the subsequent stages of treatment, when higher gauge rectangular wires are used, the clip starts to have an active function, exerting pressure on the archwire and providing better control of the torque and rotation, allowing a more accurate expression of the prescription used.



Features the exclusive patented LB2—Laser Bonded Booster, a laser texturing process on the base that increases retention and ensures greater adhesion efficiency.

U-CLIP ROTH 0.022 SELF-LIGATING BRACKETS:

TORQUE	-7°	-7°	-2°	+8°	+12°	+12°	+8°	-2°	-7°	-7°
ANGULATION	0°	0°	11°	9°	5°	5°	9°	11°	0°	0°
HOOK	✓	✓	✓	-	-	-	-	✓	✓	✓
WIDTH (mm)	3.0	3.0	3.0	3.0	3.0	3.0	3.0	3.0	3.0	3.0
ITEM NUMBER	900933	900933	900932	900931	900930	900934	900935	900936	900937	900937
	▲ 5 15	▲ 4 14	▲ 3 13	▲ 2 12	▲ 1 11	▲ 1 21	▲ 2 22	▲ 3 23	▲ 4 24	▲ 5 25
	UR4/5	UR4/5	UR3	UR2	UR1	UL1	UL2	UL3	UL4/5	UL4/5
MAXILLARY										
	Upper Right									Upper Left
MANDIBULAR										
	LR5	LR4	LR3	L2-2	L2-2	L2-2	L2-2	LL3	LL4	LL5
	45 5	44 4	43 3	42 2	41 1	31 1	32 2	33 3	34 4	35 5
TORQUE	-22°	-17°	-11°	0°	0°	0°	0°	-11°	-17°	-22°
ANGULATION	0°	0°	5°	0°	0°	0°	0°	5°	0°	0°
HOOK	✓	✓	✓	-	-	-	-	✓	✓	✓
WIDTH (mm)	3.0	3.0	3.1	2.7	2.7	2.7	2.7	3.1	3.0	3.0
ITEM NUMBER	900944	900943	900942	900938	900938	900938	900938	900939	900940	900941

Brackets & Tubes



Sold in 5-5 kits and bags of 5 brackets/tooth

PRESCRIPTION	ITEM NUMBER
5-5 KIT	900805



ICERAM-P POLYCRYSTALLINE BRACKETS

ICERam-P brackets are made of polycrystalline aluminum oxide and submitted to a state-of-the-art treatment that causes them to become transparent and practically invisible, similar to Sapphire brackets

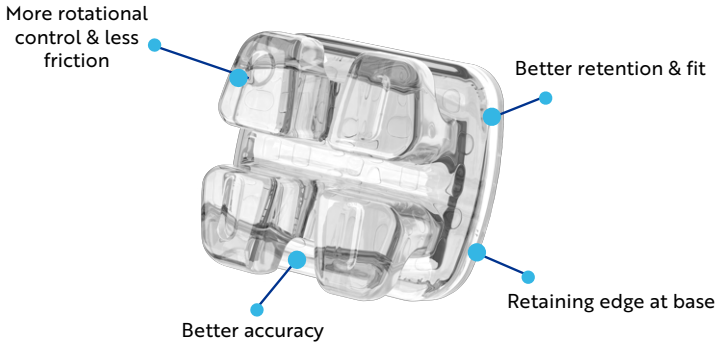

Resistant to pigmentation, maintaining their cosmetic features from the beginning to the end of treatment, with no deterioration or color change.



Features a base design with retention pins and exclusive patented laser texturing – LB2 Laser Bond Booster – giving the brackets up to 30% higher retention.



Feature low profile, rounded edges and spherical ball hooks for increased patient comfort.



Anatomical base with mesiodistal and occlusal-gingival curvatures. Retaining edges on the base prevent resin leakage and facilitate the removal of excess adhesive.

www.specialtyappliances.com

ICERAM-P ROTH 0.022 POLYCRYSTALLINE BRACKETS:

Brackets & Tubes

TORQUE	-7°	-7°	-2°	+8°	+12°	+12°	+8°	-2°	-7°	-7°
ANGULATION	0°	0°	11°	9°	5°	5°	9°	11°	0°	0°
HOOK	✓	✓	✓	-	-	-	-	✓	✓	✓
WIDTH (mm)	3.2	3.2	3.7	3.2	3.7	3.7	3.2	3.7	3.2	3.2
ITEM NUMBER	900948	900948	900947	900946	900945	900949	900950	900951	900952	900952
	▲ 5 15	▲ 4 14	▲ 3 13	▲ 2 12	▲ 1 11	▲ 1 21	▲ 2 22	▲ 3 23	▲ 4 24	▲ 5 25
	UR4/5	UR4/5	UR3	UR2	UR1	UL1	UL2	UL3	UL4/5	UL4/5
MAXILLARY										
	Upper Right Lower Right									Upper Left Lower Left
MANDIBULAR										
	LR5	LR4	LR3	L2-2	L2-2	L2-2	L2-2	LL3	LL4	LL5
	45 5	44 4	43 3	42 2	41 1	31 1	32 2	33 3	34 4	35 5
TORQUE	-22°	-17°	-11°	0°	0°	0°	0°	-11°	-17°	-22°
ANGULATION	0°	0°	5°	0°	0°	0°	0°	5°	0°	0°
HOOK	✓	✓	✓	-	-	-	-	✓	✓	✓
WIDTH (mm)	3.2	3.2	3.7	2.9	2.9	2.9	2.9	3.7	3.2	3.2
ITEM NUMBER	900959	900958	900957	900953	900953	900953	900953	900954	900955	900956



Sold in 5-5 kits and bags of 5 brackets/tooth

PRESCRIPTION	ITEM NUMBER
5-5 KIT	900810

www.specialtyappliances.com

ICERAM-P MBT 0.022 POLYCRYSTALLINE BRACKETS:

TORQUE	-7°	-7°	0°	+10°	+17°	+17°	+10°	0°	-7°	-7°
ANGULATION	0°	0°	8°	8°	4°	4°	8°	8°	0°	0°
HOOK	✓	✓	✓	-	-	-	-	✓	✓	✓
WIDTH (mm)	3.2	3.2	3.7	3.2	3.7	3.7	3.2	3.7	3.2	3.2

ITEM NUMBER **900963** **900963** **900962** **900961** **900960** **900964** **900965** **900966** **900967** **900967**



UR4/5 **UR4/5** **UR3** **UR2** **UR1** **UL1** **UL2** **UL3** **UL4/5** **UL4/5**

MAXILLARY

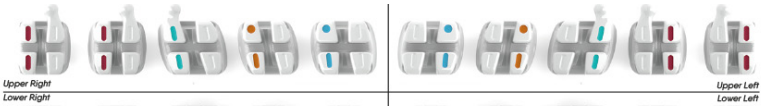

MANDIBULAR



LR5 **LR4** **LR3** **L2-2** **L2-2** **L2-2** **L2-2** **LL3** **LL4** **LL5**

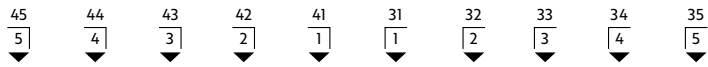

TORQUE	-17°	-12°	0°	-6°	-6°	-6°	-6°	0°	-12°	-17°
ANGULATION	2°	2°	3°	0°	0°	0°	0°	3°	2°	2°
HOOK	✓	✓	✓	-	-	-	-	✓	✓	✓
WIDTH (mm)	3.2	3.2	3.7	2.9	2.9	2.9	2.9	3.7	3.2	3.2

ITEM NUMBER **900974** **900973** **900972** **900968** **900968** **900968** **900968** **900968** **900969** **900970** **900971**



Sold in 5-5 kits and bags of 5 brackets/tooth

PRESCRIPTION	ITEM NUMBER
5-5 KIT	900820

ADVANCED SERIES TUBES

The Orthometric Advanced Series Tubes are produced using the modern MIM metallurgy process. They feature a permanent engraving indicating the correct position of each tube and can be used for 1st and 2nd molars (6s and 7s) and feature a top-notch that allows better control when positioning the tube

Advanced Series Tubes have a spherical hook that provides more comfort to the patient and excellent accommodation for elastics. They have a tapered tube entry to facilitate archwire insertion, tweezer lodgment to facilitate tube positioning, and an anatomical base with mesiodistal and occlusal gingival curvatures, buccal groove & smooth edges for a better fit.

Brackets & Tubes

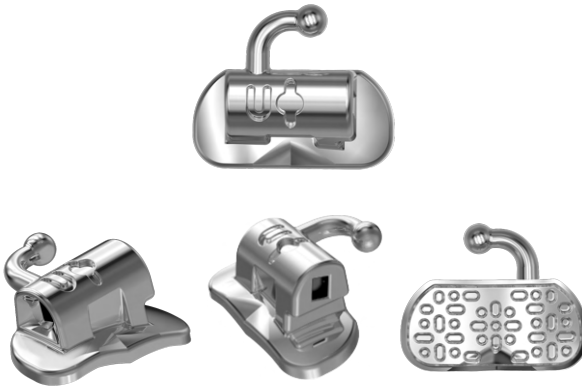

PRESCRIPTION	TOOTH	ITEM NUMBER	PRESCRIPTION	TOOTH	ITEM NUMBER
MBT 0.022 SINGLE NON-CON	LL6/7	900981	ROTH 0.022 SINGLE NON-CON	LL6/7	900819
MBT 0.022 SINGLE NON-CON	LR6/7	900982	ROTH 0.022 SINGLE NON-CON	LR6/7	900821
MBT 0.022 SINGLE NON-CON	UL6/7	900980	ROTH 0.022 SINGLE NON-CON	UL6/7	900817
MBT 0.022 SINGLE NON-CON	UR6/7	900979	ROTH 0.022 SINGLE NON-CON	UR6/7	900815

PRESCRIPTION	TOOTH	ITEM NUMBER
STANDARD SINGLE CON	LL6/7	900829
STANDARD SINGLE CON	LR6/7	900831
STANDARD SINGLE CON	UL6/7	900827
STANDARD SINGLE CON	UR6/7	900825



Sold in packs of 10

www.specialtyappliances.com



ICERAM MINI TUBES

The ICERam Mini Tube is produced with transparent polycrystalline ceramic, also known as Polly Sapphire through the extremely efficient CIM Process– Ceramic Injection Molding, that ensures aesthetic, resistance and durability.

Due to its reduced size, anatomic design, and round edges, it offers a lot more comfort to the patient and increase the possibilities of application to the orthodontist. It also allows bonding in situations of difficult access, such as partially erupted second molars, where only the mesiobuccal cusp is visible. Its universal design allows use on upper and lower arches.

Sold in packs of 2.

ITEM NUMBER

900987





ARCHWIRES

Archwire Diagram 

Flexy NiTi Copper 

Flexy NiTi Super Elastic 

Flexy NiTi Thermal 

Stainless Steel 



ARCHWIRE DIAGRAM

Archwires

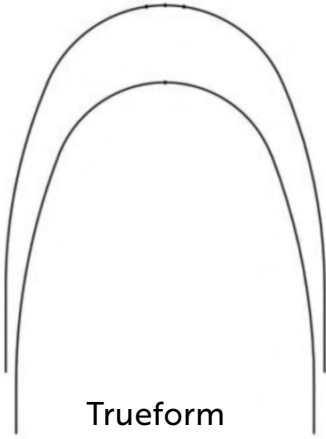

Trueform

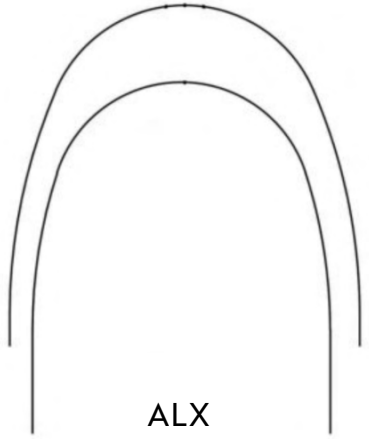

ALX



FLEXY NITI COPPER

Flexy NiTi Copper Archwires are the result of the great technological advances in biomaterials combined with cutting-edge engineering. Copper promotes accurate shape memory and greater resistance to permanent deformation compared to conventional alloys. It also leverages the thermal properties of the archwire and highlights its elasticity capacity, providing greater performance and consistency in tooth movement.



Copper makes up 6% of its composition

Sold in packs of 10

Archwires

DIMENSIONS	UPPER	LOWER	QTY
0.012"	901200	901210	10
0.014"	901201	901211	10
0.016"	901202	901212	10
0.018"	901203	901213	10
0.016" x 0.022"	901204	901214	10
0.014" x 0.025"	901205	901215	10
0.016" x 0.025"	901206	901216	10
0.017" x 0.025"	901207	901217	10
0.018" x 0.025"	901208	901218	10
0.019" x 0.025"	901209	901219	10



FLEXY NITI SUPER ELASTIC

Preformed archwires designed to provide alignment, rotation and leveling with safety and comfort for your patient. Given their high flexibility coefficient, these archwires correct crowding without the need for bending. Flexy NiTi Super Elastic rectangular archwires can be very effective for aligning and leveling brackets, preparing them to receive the stiffest, thickest wires typically required for finishing mechanics.

Archwires



Available in Trueform and ALX format

Sold in packs of 10

TRUEFORM

DIMENSIONS	UPPER	LOWER	QTY
0.012"	901156	901167	10
0.014"	901157	901168	10
0.016"	901158	901169	10
0.018"	901159	901170	10
0.020"	901160	901171	10
0.016" x 0.016"	901161	901172	10
0.016" x 0.022"	901162	901173	10
0.017" x 0.025"	901163	901174	10
0.018" x 0.025"	901164	901175	10
0.019" x 0.025"	901165	901176	10
0.021" x 0.025"	901166	901177	10

ALX

DIMENSIONS	UPPER	LOWER	QTY
0.012"	901178	901189	10
0.014"	901179	901190	10
0.016"	901180	901191	10
0.018"	901181	901192	10
0.020"	901182	901193	10
0.016" x 0.016"	901183	901194	10
0.016" x 0.022"	901184	901195	10
0.017" x 0.025"	901185	901196	10
0.018" x 0.025"	901186	901197	10
0.019" x 0.025"	901187	901198	10
0.021" x 0.025"	901188	901199	10

FLEXY NITI THERMAL

The Orthometric Flexy NiTi Thermal Archwires are thermally activated at 35°C, which provides greater flexibility with lighter and more continuous forces compared to conventional NiTi alloys. These are ideal for a safe biological response during tooth movement. The activation above room temperature and close to body temperature makes it easier to adapt to the oral cavity.



Available in Trueform and ALX format

Sold in packs of 10

Archwires

TRUEFORM

DIMENSIONS	UPPER	LOWER	QTY
0.012"	901134	901145	10
0.014"	901135	901146	10
0.016"	901136	901147	10
0.018"	901137	901148	10
0.020"	901138	901149	10
0.016" x 0.016"	901139	901150	10
0.016" x 0.022"	901140	901151	10
0.017" x 0.025"	901141	901152	10
0.018" x 0.025"	901142	901153	10
0.019" x 0.025"	901143	901154	10
0.021" x 0.025"	901144	901155	10

ALX

DIMENSIONS	UPPER	LOWER	QTY
0.012"	90110	901122	10
0.014"	901111	901123	10
0.016"	901112	901124	10
0.018"	901113	901125	10
0.020"	901114	901126	10
0.016" x 0.016"	901115	901127	10
0.016" x 0.022"	901116	901128	10
0.017" x 0.025"	901118	901129	10
0.018" x 0.025"	901119	901130	10
0.019" x 0.025"	901120	901131	10
0.021" x 0.025"	901121	901132	10

STAINLESS STEEL

Orthometric Stainless Steel Archwires are manufactured with a superior nickel-chrome alloy (stainless steel) that provides excellent surface finishing and polishing, ensuring the high quality of the product. The archwires have excellent surface gloss and good formability, weldability and strength.

Archwires



Sold in packs of 10

DIMENSIONS	UPPER	LOWER	QTY
0.012"	901220	901231	10
0.014"	901221	901232	10
0.016"	901222	901233	10
0.018"	901223	901234	10
0.020"	901224	901235	10
0.016" x 0.016"	901225	901236	10
0.016" x 0.022"	901226	901237	10
0.017" x 0.025"	901227	901238	10
0.018" x 0.025"	901228	901239	10
0.019" x 0.025"	901229	901240	10
0.021" x 0.025"	901230	901241	10



DISTALIZER

ICERam Class II Clear Distalizer 



ICERAM CLASS II CLEAR DISTALIZER

The ICERam Distalizer is an aesthetic orthodontic appliance used to treat Class II patients in permanent or mixed dentition and which connects the maxillary canine or premolar to the first or second molar. It has excellent patient acceptance, as it is aesthetic and comfortable.

Distalizer



Kit includes 1 pair of each size



Packs include 2 pieces

SIZE SELECTION: Size selection is performed with the aid of a flexible millimeter ruler, which must be positioned from the buccal central sulcus of the first molar to the center of the buccal face of the canine.

Depending on the distance obtained by the ruler, the Iceram Distalizer can be equal or different sizes on each side, right and left.







Available in 3 lengths identified by color

DIMENSION	QTY	ITEM NUMBER
KIT	6	900853
23mm	2	900850
25mm	2	900851
27mm	2	900852



ELASTOMERICS

- Orthometric Ligature Ties 
- Orthometric Elastomeric Chain 
- Orthometric Intraoral Elastics 
- Orthometric Elastic Separators 



ORTHOMETRIC LIGATURE TIES

Orthometric Ligature Ties are manufactured with a unique design that facilitates the application of ligatures and their fitting to the bracket wings.

They have excellent elasticity, keeping their force active for longer and meeting all memory and resistance requirements to provide an efficient and high-quality treatment.

Ligature Ties are sold have a total of 1012 pieces per package. This enables the individualization of the product and prevents possible cross-contamination.

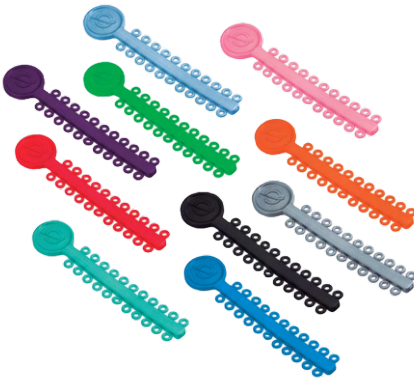

Sold in packages of 46 sticks with 22 ligatures in each stick



COLOR SELECTION:



Assorted

901089



Baby Blue

901084



Baby Pink

901085



Black

901072



Blue

901069



Crystal

901076



Crystal Blue

901077



Crystal Grape

901091



Crystal Green

901074



Crystal Red

901086



Gray

901075



Lemon Yellow

901082



Lilac

901081



Navy Blue

901078



Ocean Green

901073



Orange

901092



Pearl

901087



Pearl Blue

901088



Pearl Green

901090



Pink

901071



Purple

901079



Red

901070



Silver

901083



White

901080

Elasto**o**meric**s**

ORTHOMETRIC ELASTOMERIC CHAIN

Orthometric Elastomeric Chain presents excellent shape memory, color stability, and non-toxicity. It is made up of specific polymers that are more resistant to absorption and pigmentation, ensuring less color change and deformation during use.

Orthometric Elastomeric Chain comes in 23 different colors and is offered in short (continuous), medium, and long link lengths.



Sold in rolls of 4.5 m.

CHAIN LENGTH:

Elastic Chains • Short



Elastic Chains • Medium

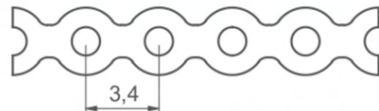

Elastic Chains • Long

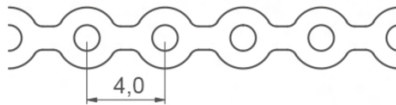

COLOR & LENGTH SELECTION:

COLOR	SHORT	MEDIUM	LONG
 BABY BLUE	901026	901004	901064
 BABY PINK	901027	901016	901040
 BLACK	901009	901051	901034
 BLUE	901019	901002	901055
 CRYSTAL	901010	901052	901036
 CRYSTAL BLUE	901023	901013	901042
 CRYSTAL GRAPE	901039	901033	901043
 CRYSTAL GREEN	901044	901012	901041
 CRYSTAL RED	901048	901053	901038
 GRAY	901005	901001	901035
 LEMON YELLOW	901047	901015	901063
 LILAC	901046	901014	901062
 NAVY BLUE	901024	901003	901059
 OCEAN GREEN	901022	901006	901058
 ORANGE	901050	901054	901068
 PEARL	901028	901032	901065
 PEARL BLUE	901029	901017	901066
 PEARL GREEN	901049	901018	901067
 PINK	901021	901030	901057
 PURPLE	901025	901007	901060
 RED	901020	901000	901056
 SILVER	901011	901008	901037
 WHITE	901045	901031	901061

Elastoo**meric**s****















ORTHOMETRIC INTRAORAL ELASTICS

Orthometric Intraoral Elastics are made of the highest quality using surgical latex, delivering consistent forces you can rely on.

The different sizes and forces are associated with animals from the Brazilian Fauna, making it easier for patients to identify them. Orthometric Intraoral Elastics feature excellent shape memory. They come in ziplock bags with printed identification for patients and feature a mint aroma.



Sold in 50 bags of 100

DIMENSION	1/8" 3.2mm	3/16" 4.8mm	1/4" 6.3mm	5/16" 7.9mm	3/8" 9.5mm
FORCE LIGHT 2.5oz 71g	Golden Lion Tamarin 	Hyacinth Macaw 	Toucan 	Peacock Bass 	Sloth 
ITEM NUMBER	901095	901098	901101	901104	901107
FORCE MEDIUM 4.5oz 128g	Capybara 	Maned Wolf 	Turtle 	Armadillo 	Anteater 
ITEM NUMBER	901096	901099	901102	901105	901108
FORCE HEAVY 6.5oz 184g	Jaguar 	Pink River Dolphin 	Tapir 	Alligator 	Wild Pig 
ITEM NUMBER	901097	901100	901103	901106	901109



ORTHOMETRIC ELASTIC SEPARATORS

Orthometric Elastic Separators are used to open the interdental space required for band placing. They are characterized for being evidenced in radiographs.



ELASTOMERS	DIMENSIONS	ITEM NUMBER
GREEN SEPARATORS	3/16"	901093







ELASTOMERS	DIMENSIONS	ITEM NUMBER
BLUE SEPARATORS	5/32"	901094



Sold in packs of 1000



ATTACHMENTS

- Archwire Tubing 
- Archwire Tubes 
- Orthometric Bonding Button 
- Orthometric Stops 
- Orthometric Straight Ball Hooks for Wires 



022x028 12 ARCHWIRE TUBING

Stainless steel archwire tubing that can be cut to desired length.

Sold in 11 inch pieces. Standard size is .022 x .028 slot.

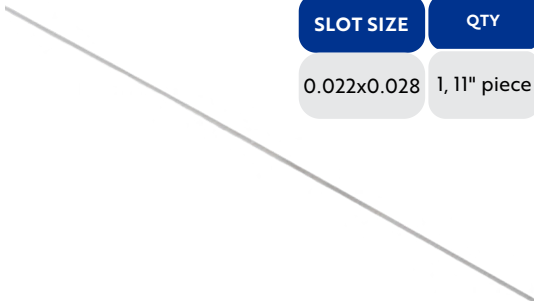

SLOT SIZE	QTY	ITEM NUMBER
0.022x0.028	1, 11" piece	900010

022x028 ARCHWIRE TUBES

Stainless steel weldable archwire tubes. The standard size is a .022 x .028 slot.

Sold in packs of 10

PRESCRIPTION	QTY	ITEM NUMBER
LEFT	10	900005
RIGHT	10	900000



ORTHOMETRIC BONDING BUTTON

Orthometric's Bonding Buttons are used to retain elastics and ligatures and are indicated for the correction of gyroversions, traction of impacted teeth, correction of midlines, and for the use of intermaxillary elastics. These are made of stainless steel and feature rounded edges to promote patient comfort.

STRAIGHT



CONVEX



CONCAVE



PRESCRIPTION	QTY	ITEM NUMBER
STRAIGHT	10	901267
CONVEX	10	901268
CONCAVE	10	901269



Sold in packs of 10



ORTHOMETRIC STOPS

Orthometric stops were developed to restrict the movement of accessories such as springs and archwires. These prevent discomfort caused by the intraoral archwire tips, facilitate the replacement by the next archwire when identifying the position of the midline, and are suitable for application on metallic, ceramic, composite and self-ligating brackets.

OPEN STOP for RECTANGULAR WIRE: Made of stainless steel alloy using MIM (metal injection molding) technology, resulting in precise pieces with excellent surface finish

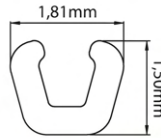

QTY	ITEM NUMBER
10	901264



Sold in packs of 10

CLOSED STOP for ROUND WIRE: Made of 316 stainless steel from drawn tubes, ensuring excellent precision and surface finish

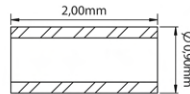

QTY	ITEM NUMBER
10	901265



Sold in packs of 25

ORTHOMETRIC STRAIGHT BALL HOOKS FOR WIRES

Orthometric's Straight Ball Hooks for Wires are indicated for anchoring elastic in chains, springs, metal ligature wires to aid of treatments that involve retraction, mesialization, anchoring and others.

Made of stainless steel, the MIM manufacturing process results in precise pieces with an excellent surface finish. These can be used in archwires up to 0.021" x 0.025". Fixation on rectangular archwires is better because of their size.

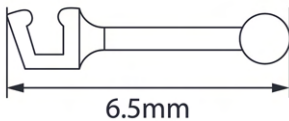

QTY	ITEM NUMBER
10	901266



Sold in packs of 10



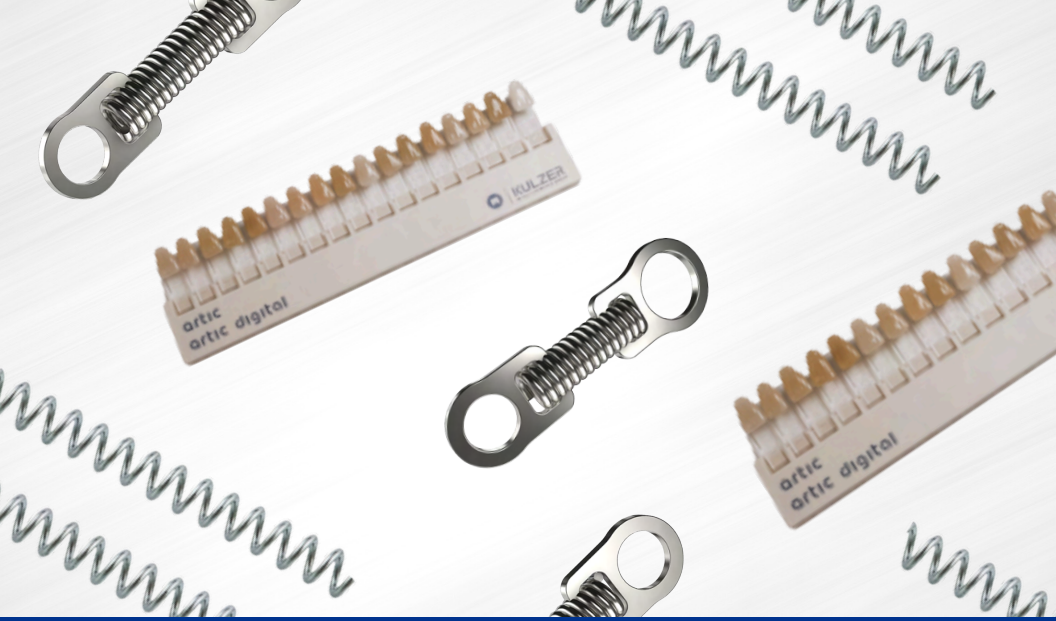

ACCESSORIES

- Flexy NiTi Closed Spring** 
- Flexy NiTi Closed Spring for Mini Screws** 
- Flexy NiTi Open Spring** 
- Pontic Shade Guides** 



FLEXY NITI CLOSED SPRING

Orthometric's Flexy NiTi Closed Springs promote space closure with light, low-intensity forces, providing the most reliable and predictable results. These springs are ideal for mini-implants as they feature smaller fixation rings, made in the spring structure itself, avoiding the risk of breakage.



Closed Spring



Closed Spring for Mini Screw

Accessories

CLOSED SPRING

PRESCRIPTION	DIMENSION	QTY	ITEM NUMBER
CLOSED SPRING	7mm	4	901255
CLOSED SPRING	9mm	4	901256
CLOSED SPRING	12mm	4	901257
CLOSED SPRING	15mm	4	901258

CLOSED SPRING FOR MINI SCREW

PRESCRIPTION	DIMENSION	QTY	ITEM NUMBER
CLOSED SPRING	7mm	4	901260
CLOSED SPRING	9mm	4	901261
CLOSED SPRING	12mm	4	901262
CLOSED SPRING	15mm	4	901263



Sold in packs of 4



FLEXY NITI OPEN SPRING

Orthometric's Flexy NiTi Open Springs are ideal for opening up space during leveling and alignment, delivering precise, smooth force components, ensuring high treatment effectiveness and resilience.

Sold in packs of 3.



PRESCRIPTION	DIMENSION	QTY	ITEM NUMBER
OPEN SPRING	0.75mm x 178mm	3	901259



PONTIC SHADE GUIDES

Our pontic shade guides ensure that the correct tooth color will be selected. There are multiple shade guides on the market. It's important to use the same shade guides between lab and practice to ensure correct shade matches.



ITEM NUMBER	900161
-------------	--------





BONDING MATERIALS

GC Aligner Connect 

GC Etching Gel 

GC Ortho Connect 

GC Ortho Connect Flow 

GC Fuji Ortho Band LC Automix Starter Kit 

GC Fuji Ortho Band LC Paste Pak Refill 

GC Fuji Ortho LC Paste Pak Automix Set 

GC Fuji Ortho LC Paste Pak Refill 

GC Mixing Tips for GC Fuji Ortho LC 





GC ALIGNER CONNECT

GC Aligner Connect is specifically formulated for aligner attachments. It features optimal durability, excellent aesthetics, high wear resistance, stain resistance, and light-cure bonding.

GC Aligner Connect features enhanced aesthetics that imitate enamel color shades and high durability, which limits long-term wear or potential detachment during treatment. Adhesion is achieved with a light-cure bonding agent such as G-premio Bond, Ortho Solo or Assure.

Contains 1 syringe of 3.4 g composite, 20 dispensing tips, and light-protective cap.



ITEM NUMBER

901287

GC ETCHING GEL

GC Etching Gel is a gel etchant that makes your bonding procedure safer and reduces waste by eliminating splash and over-dispensing of liquid. Specially designed tips aid in control and efficiency even further.

Contains 2 syringes of 4.8g and 40 dispensing tips.



ITEM NUMBER

901290





GC ORTHO CONNECT

GC Ortho Connect is a one step light cure adhesive used to bond brackets. It features the same viscosity as leading materials but with greater strength and flexibility. When using GC Ortho Connect, no primer is necessary, since it is already incorporated into the adhesive, thus creating a simplified bonding process that reduces costs.

Contains 2 syringes of 2.9 gram and 4 dispensing tips.



ITEM NUMBER

901285

Bonding Materials

GC ORTHO CONNECT FLOW

GC Ortho Connect Flow is a one-step light cure system used to bond Fixed Lingual Retainers. Ortho Connect Flow's primer is integrated into the paste, allowing to save valuable time in the bonding process.

Contains 2 syringes of 2.7 grams each with 30 plastic dispensing tips.



ITEM NUMBER

901286





GC FUJI ORTHO BAND LC AUTOMIX STARTER KIT

GC Fuji Ortho Band LC Automix Starter Kit is a dual-cured resin-reinforced orthodontic glass ionomer adhesive used to bond bands. It features wet field compatibility to make it faster and easier to deliver bands. Sustained fluoride release prevents white spot formations.

Contains 2 x 13.3 g cartridges, 1 GC Paste Pak Dispenser, 20 mixing tips and 1 mixing pad.



ITEM NUMBER **901288**

GC FUJI ORTHO BAND LC PASTE PAK REFILL

GC Fuji Ortho Band LC A is a dual-cured resin-reinforced orthodontic glass ionomer adhesive that is used to bond bands. Fuji Ortho Band LC features wet field compatibility to make it faster and easier to deliver bands. Sustained fluoride release prevents white spot formations.

Contains 2 x 13.3 paste pak cartridges and 1 mixing pad.



ITEM NUMBER **901291**

Bonding Materials





GC FUJI ORTHO LC PASTE PAK AUTOMIX SET

GC Fuji Ortho LC Automix Starter Kit is a dual-cured resin-reinforced orthodontic glass ionomer adhesive used to bond brackets. Fuji Ortho LC features wet field compatibility to make it faster and easier to deliver brackets. Sustained fluoride release prevents white spot formations.

Contains 1 x 13.3 g paste pak cartridge, 2 ortho gel conditioner syringes, 3 mixing tips and 15 brush tips.



ITEM NUMBER

901289

GC FUJI ORTHO LC PASTE PAK REFILL

GC Fuji Ortho LC Automix is a dual-cured resin-reinforced orthodontic glass ionomer adhesive used to bond brackets. Fuji Ortho LC features wet field compatibility to make it faster and easier to deliver brackets. Sustained fluoride release prevents white spot formations.

Contains 2 x 13.3 g paste pak cartridges.



ITEM NUMBER

901293





GC MIXING TIPS FOR GC FUJI ORTHO LC

Replacement tips for Fuji ORTHO BAND LC.

Contains 20 mixing tips.



ITEM NUMBER

901292

Bonding Materials





IMPRESSION MATERIAL

DentMix VPS Impression Material 

DentMix Bite Registration 

DentMix Putty 

DentMix Intraoral Top 

DentMix Mixing Tips 



DENTMIX VPS IMPRESSION MATERIAL

DentMix VPS Impression Material's unique formulation is extremely hydrophilic, has a low contract angle, and exceptional tear strength giving you the confidence that your impressions will be right every time. DentMix features outstanding dimensional stability, a vibrant color palette, pleasant flavoring that reduces the gag reflex, and excellent elastic recovery.

HEAVY BODY VPS IMPRESSION MATERIAL:



PRESCRIPTION	QTY	ITEM NUMBER
FAST SET	2pk	901303
FAST SET	4pk	901304
REGULAR SET	2pk	901295
REGULAR SET	4pk	901296

LIGHT BODY VPS IMPRESSION MATERIAL:



PRESCRIPTION	QTY	ITEM NUMBER
FAST SET	2pk	901307
FAST SET	4pk	901308
REGULAR SET	2pk	901299
REGULAR SET	4pk	901300

MONOPHASE VPS IMPRESSION MATERIAL:



PRESCRIPTION	QTY	ITEM NUMBER
FAST SET	2pk	901305
FAST SET	4pk	901306
REGULAR SET	2pk	901297
REGULAR SET	4pk	901298

DENTMIX BITE REGISTRATION

The DentMix Bite Registration Material and Putty is thixotropic and features a pillowy consistency, allowing for optimal detail and ease of use. The material is durable, tear resistant, and distortion free.



PRESCRIPTION	QTY	ITEM NUMBER
BITE REGISTRATION	2pk	901301
BITE REGISTRATION	4pk	901302

Impression Material

DENTMIX PUTTY



PRESCRIPTION	ITEM NUMBER
FAST SET	901309
REGULAR SET	901310



DENTMIX INTRAORAL TIPS

DentMix Intraoral Tips provide a precise interproximal placement. These tips attach to Dentmix's patented 4.2 ml mixing tips and competitive comparable products.

Sold in packs of 100.



ITEM NUMBER

901313

DENTMIX MIXING TIPS

DentMix Mixing Tips feature a patent-pending Visual Identification System (VID) that takes the guesswork out of selecting tips for your dental mixing needs. No more fumbling around trying to find the right color code. Simply check the tip for the number that correlates with your mixing formulation, and you're ready to work.

DentMix's Brite Green Mixing Tips are best for Light Body VPS, and DentMix Grape Mixing Tips are best for Heavy Body and Bite Registration.

Sold in 50 tips per pack.



PRESCRIPTION

ITEM NUMBER

BRITE GREEN

901312

CONCORD GRAPE

901311



KITS & REPLENISHMENTS

Crown Components for Herbst 

ROC Components for Herbst 

OnBRACE® 

Crowns 

ROCs 



CROWN COMPONENTS FOR HERBST

Kits & Replenishments

UPPER CROWN KIT FOR HERBST: The Upper MiniSkirt Crowns are an original Specialty Design. The MiniSkirt crowns are pretrimmed so they don't overextend gingivally.

The Upper Crown Kit for Herbst contains packs of 5 crowns per tooth in Upper Right and Upper Left sizes 4-8.



ITEM NUMBER **900627**

UPPER CROWN PACK FOR HERBST: The Upper MiniSkirt Crowns are an original Specialty Design. The MiniSkirt crowns are pretrimmed so they don't overextend gingivally.

Sold in packs of 5.



TOOTH	ITEM NUMBER
UL4	900646
UL5	900647
UL6	900648
UL7	900649
UL8	900650
UR4	900641
UR5	900642
UR6	900643
UR7	900644
UR8	900645

LOWER CROWN KIT FOR HERBST: The Lower MiniSkirt Crowns are an original Specialty Design. The MiniSkirt crowns are pretrimmed so they don't overextend gingivally.

The Lower Crown Kit for Herbst contains packs of 5 crowns per tooth in Lower Right and Lower Left sizes 4-8 with Cantilever arm lengths of 8mm, 10mm, 12mm and 14mm.



ITEM NUMBER **900628**

LOWER CROWN PACK FOR HERBST: The Lower MiniSkirt Crowns are an original Specialty Design. The MiniSkirt crowns are pretrimmed so they don't overextend gingivally. Lower Crowns for Herbst are sold in packs of 5. Available in sizes 4-8 with Cantilever arm lengths of 8mm, 10mm, 12mm and 14mm.



TOOTH	DIMENSION	ITEM NUMBER
LL4	8mm	900711
LL4	10mm	900716
LL4	12mm	900721
LL4	14mm	900726
LL5	8mm	900712
LL5	10mm	900717
LL5	12mm	900722
LL5	14mm	900727
LL6	8mm	900713
LL6	10mm	900718
LL6	12mm	900723
LL6	14mm	900728
LL7	8mm	900714
LL7	10mm	900719
LL7	12mm	900724
LL7	14mm	900729
LL8	8mm	900715
LL8	10mm	900720
LL8	12mm	900725
LL8	14mm	900730

TOOTH	DIMENSION	ITEM NUMBER
LR4	8mm	900691
LR4	10mm	900696
LR4	12mm	900701
LR5	14mm	900706
LR5	8mm	900692
LR5	10mm	900697
LR5	12mm	900702
LR5	14mm	900707
LR6	8mm	900693
LR6	10mm	900698
LR6	12mm	900703
LR6	14mm	900708
LR7	8mm	900694
LR7	10mm	900699
LR7	12mm	900704
LR7	14mm	900709
LR8	8mm	900695
LR8	10mm	900700
LR8	12mm	900705
LR8	14mm	900710

ROC COMPONENTS FOR HERBST

Kits & Replenishments

UPPER ROC KIT FOR HERBST: The Upper ROC Kit for Herbst contains packs of 5 ROCs per tooth in Upper Right and Upper Left sizes 4-8.



ITEM NUMBER **900625**

UPPER ROC PACK FOR HERBST: The Upper MiniSkirt ROCs are an original Specialty Design. The MiniSkirt ROCs are pretrimmed, so they don't overextend gingivally.

Sold in packs of 5.



TOOTH	ITEM NUMBER
UL4	900636
UL5	900637
UL6	900638
UL7	900639
UL8	900640
UR4	900631
UR5	900632
UR6	900633
UR7	900634
UR8	900635

LOWER ROC KIT FOR HERBST: The Lower MiniSkirt ROCs are an original Specialty Design. The MiniSkirt ROCs are pretrimmed so they don't overextend gingivally.

The Lower ROC Kit for Herbst contains packs of 5 ROCs per tooth in Lower Right and Lower Left sizes 4-8 with Cantilever arm lengths of 8mm, 10mm, 12mm and 14mm.



ITEM NUMBER **900626**

LOWER ROC PACK FOR HERBST: The Lower ROCs are an original Specialty Design. They are pretrimmed, so they don't overextend gingivally. Lower ROCs for Herbst are sold in packs of 5. Available in sizes 4-8 with Cantilever arm lengths of 8mm, 10mm, 12mm and 14mm.



TOOTH	DIMENSION	ITEM NUMBER	TOOTH	DIMENSION	ITEM NUMBER
LL4	8mm	900671	LR4	8mm	900651
LL4	10mm	900676	LR4	10mm	900656
LL4	12mm	900681	LR4	12mm	900661
LL4	14mm	900686	LR5	14mm	900666
LL5	8mm	900672	LR5	8mm	900652
LL5	10mm	900677	LR5	10mm	900657
LL5	12mm	900682	LR5	12mm	900662
LL5	14mm	900687	LR5	14mm	900667
LL6	8mm	900673	LR6	8mm	900653
LL6	10mm	900678	LR6	10mm	900658
LL6	12mm	900683	LR6	12mm	900663
LL6	14mm	900688	LR6	14mm	900668
LL7	8mm	900674	LR7	8mm	900654
LL7	10mm	900679	LR7	10mm	900659
LL7	12mm	900684	LR7	12mm	900664
LL7	14mm	900689	LR7	14mm	900669
LL8	8mm	900675	LR8	8mm	900655
LL8	10mm	900680	LR8	10mm	900660
LL8	12mm	900685	LR8	12mm	900665
LL8	14mm	900690	LR8	14mm	900670

ONBRACE®

ONBRACE® KIT: OnBRACE® is designed to make orthodontic treatment better for the patient and practitioner alike. Designed for comfort, the OnBRACE® does not extend interproximally. Without mesial or distal metal intrusion, orthodontic separators are no longer needed. An occlusal hole facilitates light curing of the dual-cure cement. OnBRACE® was designed to be used with Hyrax expanders but can also be used with Quad Helixes, Herbst appliances, MARA appliances and more.

The OnBRACE® kit contains 5 OnBRACE® crowns per tooth in sizes 2-8.



ITEM NUMBER **901317**

ONBRACE® PACKS: Packs contain 5 crowns.



TOOTH	ITEM NUMBER	TOOTH	ITEM NUMBER
LL2	901339	UL2	901325
LL3	901340	UL3	901326
LL4	901341	UL4	901327
LL5	901342	UL5	901328
LL6	901343	UL6	901329
LL7	901344	UL7	901330
LL8	901345	UL8	901331
LR2	901332	UR2	901318
LR3	901333	UR3	901319
LR4	901334	UR4	901320
LR5	901335	UR5	901321
LR6	901336	UR6	901322
LR7	901337	UR7	901323
LR8	901338	UR8	901324

CROWNS

CROWN KIT: The Specialty Products Crown Kit includes 5 Stainless Steel Crowns in each tooth size. Upper right, upper left, lower right and lower left sizes 4-8.



ITEM NUMBER **900630**

STAINLESS STEEL CROWNS: Stainless Steel Crowns are available in packs of 5. Upper left, upper right, lower left and lower right packs available in sizes 4-8.



TOOTH	ITEM NUMBER
LL4	900123
LL5	900124
LL6	900125
LL7	900126
LL8	900127
LR4	900109
LR5	900110
LR6	900111
LR7	900112
LR8	900113
UL4	900116
UL5	900117
UL6	900118
UL7	900119
UL8	900120
UR4	900102
UR5	900103
UR6	900104
UR7	900105
UR8	900106

ROCS

ROC KIT: The Specialty Products ROC Kit contains 5 ROC Crowns/Tooth in Upper Right, Upper Left, Lower Right, and Lower Left sizes 4-8.

Kits & Replenishments



ITEM NUMBER 900629



ROC CROWNS: ROC Crowns are available in packs of 5. Upper left, upper right, lower left and lower right sizes 4-8.



TOOTH	ITEM NUMBER
LL4	900154
LL5	900155
LL6	900156
LL7	900157
LL8	900158
LR4	900148
LR5	900149
LR6	900150
LR7	900151
LR8	900152
UL4	900142
UL5	900143
UL6	900144
UL7	900145
UL8	900146
UR4	900136
UR5	900137
UR6	900138
UR7	900139
UR8	900140



EXPANSION SCREWS

- Dentaurum Palex® Screws 
- Dentaurum Palex® Click Screws 
- Dentaurum Variety Screws 
- Dentaurum Variety Click Screws 



DENTAURUM PALEX® SCREWS

DENTAURUM PALEX® EXPANSION SCREWS: Dentaaurum Palex® Expansion Screws are used for rapid palatal expansion by means of fixed appliances. The screws feature built-in stops to prevent the screws from coming apart once maximum expansion has been obtained.

Expansion Screws



Sold in packs of 10

PRESCRIPTION	DIMENSION	QTY	ITEM NUMBER
PALEX® EXPANSION	MINI - 7mm	10	901271
PALEX® EXPANSION	MEDIUM - 10mm	10	901272
PALEX® EXPANSION	MAXI - 12mm	10	901273

DENTAURUM PALEX® CLICK SCREWS

DENTAURUM PALEX® CLICK EXPANSION SCREWS: Dentaaurum Palex® Click Expansion Screws are RPE screws with a click feature to prevent unwanted reversing. The Palex® Click Screw offers safe activation, high degrees of security for both the orthodontist and patient and a screw locking feature.



Sold in packs of 10

PRESCRIPTION	DIMENSION	QTY	ITEM NUMBER
PALEX® CLICK	MEDIUM - 10mm	10	901274
PALEX® CLICK	MAXI - 12mm	10	901275

DENTAURUM VARIETY SCREWS

DENTAURUM VARIETY EXPANSION SCREWS: Dentaureum Variety Expansion Screws feature two legs for fixed appliances can be used for many diverse applications in the maxilla and mandible. The compact design makes them comfortable for the patient to wear and their clever design increases safety and treatment success.



Sold in packs of 10

PRESCRIPTION	DIMENSION	QTY	ITEM NUMBER
VARIETY EXPANSION	MINI - 8mm	10	901276
VARIETY EXPANSION	MAXI - 12mm	10	901277

DENTAURUM VARIETY SMALL PALATE EXPANSION SCREWS: Dentaureum Variety Small Palate Expansion Screws feature two legs for fixed appliances that can be used for many diverse applications in the maxilla and mandible. The compact design makes them comfortable for the patient to wear, and their clever design increases safety and treatment success. The Small Palate screw is used for early palatal expansion.



Sold in packs of 10

PRESCRIPTION	DIMENSION	QTY	ITEM NUMBER
SMALL PALATE EXPANSION	MINI - 8mm	10	901278
SMALL PALATE EXPANSION	MAXI - 12mm	10	901279

Expansion Screws

DENTAURUM VARIETY CLICK SCREWS

DENTAURUM VARIETY CLICK SCREWS: Dentaureum Variety Click Screws are special expansion screws with a feature against unwanted reversing. The unwanted reversing click is the ideal screw-locking feature during the active treatment phase: it enables reliable activation and deactivation of the screw with a perceptible click after a quarter turn.

Expansion Screws



Sold in packs of 10

PRESCRIPTION	DIMENSION	QTY	ITEM NUMBER
VARIETY CLICK	MINI - 8mm	10	901280
VARIETY CLICK	MAXI - 12mm	10	901281

DENTAURUM VARIETY SMALL PALATE CLICK SCREWS: Dentaureum Variety Small Palate Click Screws are special expansion screws with a feature against unwanted reversing. The unwanted reversing click is the ideal screw-locking feature during the active treatment phase: it enables reliable activation/deactivation of the screw with a perceptible click after a quarter turn.



Sold in packs of 10

PRESCRIPTION	DIMENSION	QTY	ITEM NUMBER
SMALL PALATE CLICK	MINI - 8mm	10	901282
SMALL PALATE CLICK	MAXI - 12mm	10	901283



HERBST PARTS

- Herbst Mechanisms 
- Telescoping Cantliever Arms 
- Telescoping Nuts With Backing 
- Traditional Herbst Rods 
- Traditional Herbst Tubes 
- AppleCore® Screws 
- Telescoping Crimpable Shims 
- Traditional Herbst Hex Screws 
- Traditional Round Shims 



HERBST MECHANISMS

M4 HERBST MECHANISM: The M4 Herbst Mechanism is an original Specialty Appliances design. The M4 4-part mechanism does not come apart and is the most popular design used in the market today. Patients can have up to 64 mm of vertical opening.



PRESCRIPTION	DIMENSION	ITEM NUMBER
RIGHT	16mm	900350
RIGHT	19mm	900365
LEFT	16mm	900355
LEFT	19mm	900370

MINISCOPE HERBST MECHANISM: The MiniScope 3-part Herbst Mechanism is an original Specialty Appliances design. The MiniScope mechanism does not come apart and offers great lateral movement.



PRESCRIPTION	DIMENSION	ITEM NUMBER	PRESCRIPTION	DIMENSION	ITEM NUMBER
RIGHT	18mm	900290	LEFT	18mm	900295
RIGHT	21mm	900305	LEFT	21mm	900310
RIGHT	24mm	900320	LEFT	24mm	900325
RIGHT	27mm	900335	LEFT	27mm	900340

FLIP-LOCK® MECHANISM: The Flip-Lock® mechanism has a ball and swivel type of attachment on the upper and lower for increased lateral movement. The lower rods are universal, while the upper members are right and left specific. Flip-Lock is a registered trademark of TP Orthodontics.



PRESCRIPTION	QTY	ITEM NUMBER
LEFT ARM	Ea	900455
LEFT ARM	5/pk	900465
RIGHT ARM	Ea	900450
RIGHT ARM	5/pk	900460
LOWER ROD	Ea	900440
LOWER ROD	10/pk	900445

HTH® MECHANISM: The Hanks Telescoping Herbst, or HTH®, is a telescoping mechanism with attachment hex screws built into the connecting housings. The housings feature a ball and socket assembly that promotes lateral movement. The HTH® mechanism has a right and left side and is available in four lengths. It is specific for right and left.



PRESCRIPTION	DIMENSION	ITEM NUMBER	PRESCRIPTION	DIMENSION	ITEM NUMBER
RIGHT	16mm	900380	LEFT	16mm	900385
RIGHT	18mm	900395	LEFT	18mm	900400
RIGHT	21mm	900410	LEFT	21mm	900415
RIGHT	24mm	900425	LEFT	24mm	900430

PRESCRIPTION	DIMENSION	ITEM NUMBER
SET	21mm	900405

TELESCOPING CANTILEVER ARMS

Telescoping Cantilever Arms are machines in right and left as a single unit .022 x .028 archwire tubes are welded onto these parts for convenience.

Sold in packs of 10.



ITEM NUMBER

900216

TELESCOPING NUTS WITH BACKING

Telescoping Nuts with Backing are used with Applecore Screws. The laser welded backing prevents solder from getting into the threads from the back.



ITEM NUMBER

900490

TRADITIONAL HERBST LOWER RODS

Traditional Herbst lower rods are sold in packs of 10 and are universal.



ITEM NUMBER

900280

TRADITIONAL HERBST UPPER TUBES

Traditional Herbst Upper Tubes are left and right specific. The upper eyelet is offset 16° for best pivot alignment and the overall length of the Herbst tube is 32 mm.

Sold in packs of 5.



PRESCRIPTION	ITEM NUMBER
UPPER LEFT	900265
UPPER RIGHT	900260

APPLECORE® SCREWS

The AppleCore® Screw is a modification of the traditional hex head screw. Instead of a uniform thickness barrel, the AppleCore Screw has a curved, inner radius on the barrel. The profile of the new AppleCore screw allows greater lateral movement to reduce the amount of force placed on the appliance.

Sold in packs of 10.



ITEM NUMBER	900480
-------------	--------

TRADITIONAL ROUND SHIMS

Traditional round shims are used to advance traditional Herbst appliances.

Sold in packs of 10.



DIMENSION	ITEM NUMBER
1mm	900510
2mm	900511
3mm	900512
4mm	900513
5mm	900514

TELESCOPING CRIMPABLE SHIMS

The telescoping crimpable shims are used with the telescoping Herbst appliances. The telescoping shims are available in 1mm, 2mm, 3mm and, 4mm lengths.

It's very important to use the telescoping shims from Specialty Appliances. This is the only shim that works with the M4 mechanism.

Sold in packs of 10.



DIMENSION	ITEM NUMBER
1mm	900520
2mm	900521
3mm	900522
4mm	900523

TRADITIONAL HERBST HEX SCREWS

The original Herbst Appliance is used with hex head screws, as shown. These screws seat into the Herbst pivots and are tightened with a small Allen wrench. Traditional hex head screws are typically secured with Ceka Bond for additional strength.

Sold in packs of 10



ITEM NUMBER	900475
-------------	--------



MARA PARTS

MARA Accessory Parts 

MARA Lower Stop 

MARA Upper Tube 

MARA Elbow 

Elastic Separator for MARA 

MARA Torquing Tool 



MARA ACCESSORY PARTS

The MARA Accessory parts kit contains 10 of each 1, 2, 3, and 4mm traditional round shims. Elastic separators with 80 per pack. A MARA torquing tool and 2 MARA elbow short left, 2 MARA elbow short right, 2 standard right, and 2 standard left.

ITEM NUMBER
900245

MARA LOWER STOPS

MARA Lower Stops are available in a standard 3mm length or an extended 5mm length. Stops are sold in packs of 2 or 10.



LENGTH	PACK SIZE	ITEM NUMBER
STD - 3mm	2 pk	901407
STD - 3mm	10 pk	901408
EXT - 5mm	2 pk	901409
EXT - 5mm	10 pk	901410

MARA UPPER TUBES

MARA Upper Tubes from Specialty Products are seamless and provide ultimate strength for MARA Elbows.



PACK SIZE	ITEM NUMBER
2 pk	901411
10 pk	901412

MARA ELBOW

MARA elbows vary in size. The three sizes differ in the vertical length of the elbow.



PRESCRIPTION	DIMENSION	ITEM NUMBER	PRESCRIPTION	DIMENSION	ITEM NUMBER
RIGHT	SHORT	900185	LEFT	SHORT	900190
RIGHT	LONG	900175	LEFT	LONG	900180
RIGHT	STANDARD	900165	LEFT	STANDARD	900170

MARA Parts

ELASTIC SEPARATOR FOR MARA

Elastic separators used for separation of teeth or to hold MARA elbows in place

Sold in packs of 80.

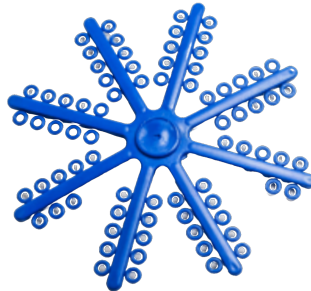

ITEM NUMBER 900163

MARA TORQUING TOOL

The MARA Torquing Tool is used to bend the upper elbow buccal and lingual in a torquing motion. You can also use to close loop on distal.



ITEM NUMBER 900600



INSTRUMENTS & TOOLS

- Debonding Pliers 
- Cutting Pliers 
- Utility Pliers 
- Aligners Pliers 
- Hand Instruments 
- Other Tools 



DEBONDING PLIERS



ORTHOMETRIC AESTHETIC BRACKET

REMOVAL PLIER: Orthometric Aesthetic Bracket Removal Pliers have a specific design consisting of two slotted active tips. The principle of use involves fixing the esthetic bracket between the tips and providing additional support to the arch in the slots in the active tips.

The accessory is removed through traction, reducing the risk of fracture and providing greater safety in the procedure.

ITEM NUMBER

901243



ORTHOMETRIC STRAIGHT BRACKET

REMOVAL PLIER: Orthometric Straight Bracket Removal Pliers have an active tip designed to fit into the interface between the accessory base and the tooth, and remove the bracket through wedge-effect pressure.

They may be used with caution to remove the coarser residue of remaining adhesive on the tooth surface, however, with care not to damage the enamel.

ITEM NUMBER

901251



ORTHOMETRIC BAND/RESIN REMOVAL

PLIER: Orthometric Band/Resin Removal Pliers with Widia have two active tips, a sharper one and the other with a replaceable plastic pad. The plastic pad adapts to the occlusal aspect of the tooth and the second tip adjusts to the neck of the band, which is removed through traction. The pliers have a second function, to scrape the remaining adhesive adhered to the tooth after debonding attachments.

ITEM NUMBER

901253



ORTHOMETRIC PLASTIC TIPS FOR REMOVAL

PLIER: Orthometric Plastic Tips for Removal Pliers are made of extremely resistant Nylon and are used as a replacement pad for band debonding pliers.

ITEM NUMBER

901246

CUTTING PLIERS



ORTHOMETRIC DISTAL CUTTING PLIER:

Orthometric Distal Cutting Pliers have active tips angled around their main axis and are used to cut the distal end of an archwire inside the oral cavity. The angled feature facilitates the approximation of the distal part of the tube. In addition, they permit cutting and holding the distal wire end at the same time, preventing the wire from getting lost in the mouth or flying into tissue.

They are recommended for use with wires up to 0.021" x 0.025".

ITEM NUMBER

901242



ORTHOMETRIC DISTAL FLUSH CUTTING

PLIER: Orthometric Distal Flush Cutting Pliers have active tips that form a 90° angle around their main axis and are used to cut the distal end of an arch inside the oral cavity. They feature reinforced active ends; and because they are manufactured with the active part in width, they allow cutting the wire safely, preventing the wire from getting lost in the mouth or flying into tissue.

They are recommended for use with wires up to 0.021" x 0.025".

ITEM NUMBER

901245



UTILITY PLIERS



ORTHOMETRIC UNIVERSAL WEINGART

PLIER: Orthometric Universal Weingart Pliers feature long, thin tips with serrations for better gripping archwires up to 0.021" X 0.025", for insertion and removal of the interior of the molar tube.

They can also be used for inserting the clip of a transpalatal bar in the lingual tube and for making the distal bend at the end of an archwire.

ITEM NUMBER

901249

ALIGNER PLIERS



ORTHOMETRIC ALIGNER BUTTON PLIER:

The Button Cutting Pliers for Aligners create a circular-shaped cut on the aligner. The cut facilitates fitting the aligner over buttons, brackets and tubes. The most frequent uses are to aid with tooth extrusion, with class II and III elastics and for hybrid mechanics. The use of pliers suitable for aligners allows a clean and burr-free cut without the need for finishing.

ITEM NUMBER

901346

HAND INSTRUMENTS



ORTHOMETRIC TORQUE WRENCH:

The Orthometric Torque Wrench is designed to produce torque in rectangular archwires.

ITEM NUMBER

901250





ORTHOMETRIC MATHEIU NEEDLE HOLDER: Orthometric Mathieu Needle Holder is a hand instrument used for fixing ligatures around the bracket wings, ligating the archwire to the accessory.

The other function is to lead the elastics in a chain from one point of the dental arch to another to produce the force necessary for tooth movement by sliding.

ITEM NUMBER 901254



ORTHOMETRIC MINI MATHEIU NEEDLE HOLDER: The Orthometric Mini Mathieu Needle Holder is a hand instrument used for fixing ligatures around the bracket wings, ligating the archwire to the accessory.

The other function is to lead the elastics in a chain from one point of the dental arch to another to produce the force necessary for tooth movement by sliding.

ITEM NUMBER 901244



ORTHOMETRIC TUBE TWEEZERS: Orthometric Tube Tweezers were designed with angled and tapered active tips that fix the tube, facilitating its proper positioning for bonding.

Although indicated for tubes, they can also be used for other orthodontic accessories.

ITEM NUMBER 901247





ORTHOMETRIC BRACKET TWEEZERS:

Orthometric Bracket Tweezers were designed to keep the bracket firmly fixed and lead it to the oral cavity, aiding in positioning the accessory during bonding.

ITEM NUMBER

901248



ORTHOMETRIC BAND SEATER: The Orthometric Band Seater is designed to resemble a lever and is intended for the initial band placement through manual pressure.

It also aids burnishing the occlusal margin of a band, promoting good band fit and reducing the interface between the metal and the tooth surface.

ITEM NUMBER

901252



OTHER TOOLS



GURIN LOCK WRENCH: The Gurin Wrench is designed to secure Gurin Locks to the wire. The locks are tied into place by positioning the slotted bolt over the arch wire and tightening the nut with the Gurin Wrench.

ITEM NUMBER

900592



SUPERscrew® WRENCH: The SUPERscrew wrench is used to activate 12mm and 16mm Super Screws.

ITEM NUMBER

900591



BALL-END HEX WRENCH: The Ball-End wrench has a unique end which allows it to be inserted into the hex screw at an angle. This facilitates clinical handling of the screws in patients where the cheeks do not allow direct access to the screws.

ITEM NUMBER

900585



HEX "L" WRENCH: L-style hex wrenches are available in 10 packs. This is the standard wrench sent with all Herbst cases.

ITEM NUMBER

900570



HEX WRENCH WITH HANDLE: This wrench is easier to handle and more durable than the "L" shaped standard hex wrench.

ITEM NUMBER

900590



RPE PLASTIC KEYS: Specialty Appliances offers the Shilliday activation key. This special design has become the industry standard for activation keys. This RPE key is used to turn all RPE Screws. Sold in packs of 10.

ITEM NUMBER

900560



PATIENT AIDS

Specialty Products Chewies 

Ortho Chewie Biters Kit 

Specialty Products Orthodontic Relief Wax 

Specialty Products Aligner Removal Tool 

Specialty Products Retainer Cases 



SPECIALTY PRODUCTS CHEWIES

Specialty Products Orthodontic Chewies are used to sit in the seating of clear aligners or invisible retainers on the teeth. Chewies come with a removable stick for sanitary seating and are unflavored.

Sold in 25 packs of 2.



ITEM NUMBER

901315

Patient Aids

ORTHOMETRIC®
Helping the World Smile

ORTHO CHEWIE BITERS KIT

OrthoChewie teethers are used to potentialize tooth movement in treatment with orthodontic aligners, through the correct adaptation of the plate on the dental arch.



Sold in 20
packs of 3

ITEM NUMBER

901270

SPECIALTY PRODUCTS ORTHODONTIC RELIEF WAX

Specialty Products Orthodontic Relief Wax is used to relieve irritation and pain caused by braces and other orthodontic appliances. Specialty Products Orthodontic Relief Wax is mint flavored and sold in 144 cases per box.

Each case contains
5 strips of wax



ITEM NUMBER

900891

SPECIALTY PRODUCTS ALIGNER REMOVAL TOOL

Specialty Products Aligner Removal Tool is used to remove clear aligners and invisible retainers. The ergonomic handle allows for simple and precise removal every single time. Sold in 25 packs with 2 in each pack.



ITEM NUMBER

901316

SPECIALTY PRODUCTS

RETAINER CASES

Specialty Products Retainer Cases sold in packs of 100 in assorted colors. 10 of each color.



ITEM NUMBER

900009



Teal



Green



Red



Blue



Orange



Yellow



Pink



Purple



Black & Clear



FOLLOW SPECIALTY APPLIANCES ON SOCIAL MEDIA

www.specialtyappliances.com